

FRANKE

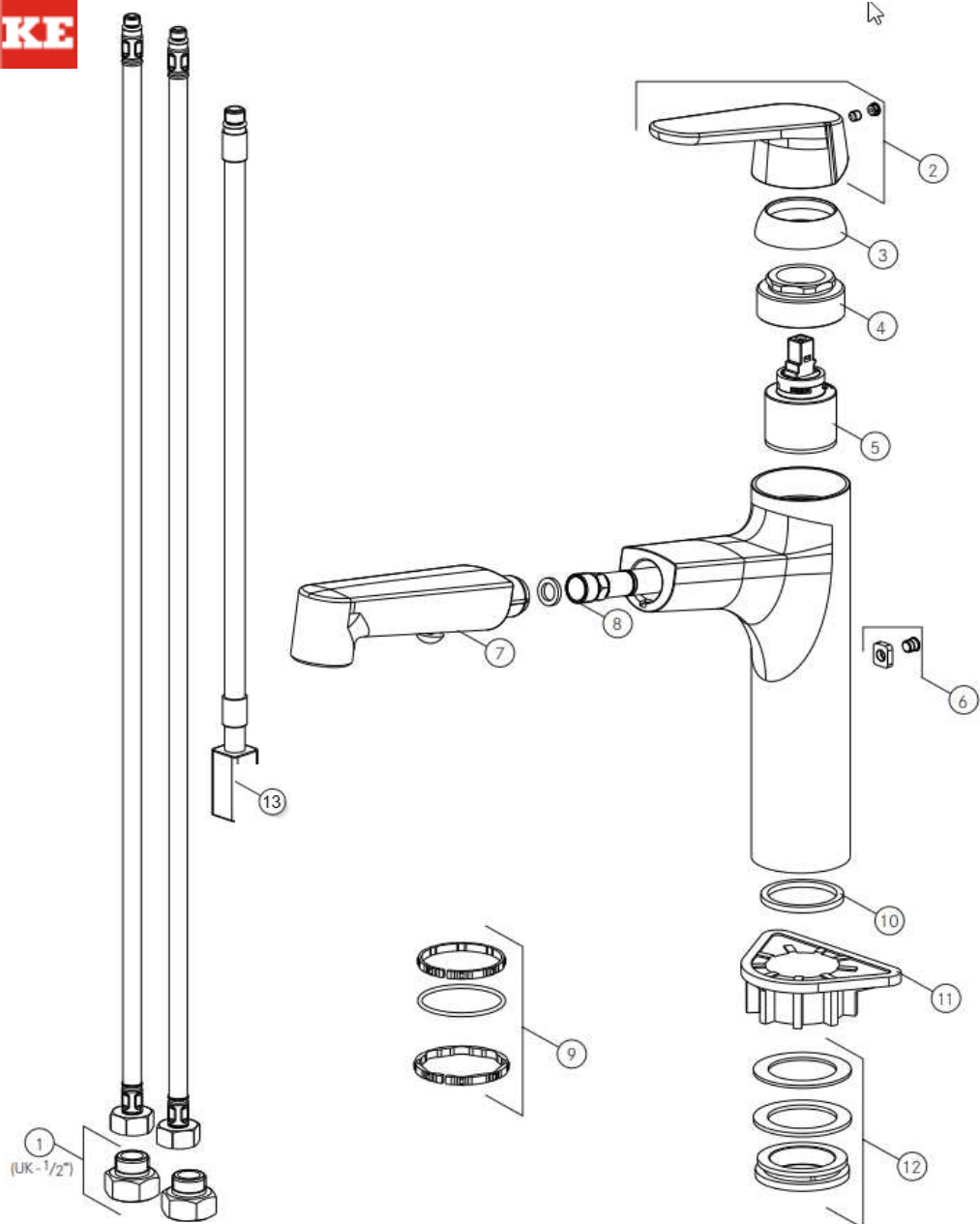

FRANKE Lift 115.0621.670

N°	Item	Description	Fun
1	Z.535.739	Übergangsnippel 3/8"-1/2" kpl.	133.0329.301
2	Z.538.723.176	Hebel kompl.	133.0628.060
3	Z.637.405.176	Kappe	133.0615.515
4	Z.639.425.176	Patronenmutter	133.0629.984
5	Z.538.757	FRANKE Steuerpatrone M 35 A	133.0629.985
6	Z.538.449.700	Anschlagplatte-Set TL	133.0604.463
7	Z.538.612.176	Brause KIRO Dual Jet M15x1	133.0628.001
8	Z.538.444.106	Auszugschlauch Kst L1800	133.0604.492
9	Z.538.441	Dichtungsset Küche Auszugbr.	133.0604.461
10	Z.638.911	Flachdichtung D40.5/34x3	660.0588.619
11	Z.532.241	Verstärkungsflansch	133.0506.560
12	Z.538.336	Befestigungs-Set M33x1.5	660.0588.634
13	Z.538.290	Flexschlauch M8x1-3/8" L600	133.0598.371