

DF

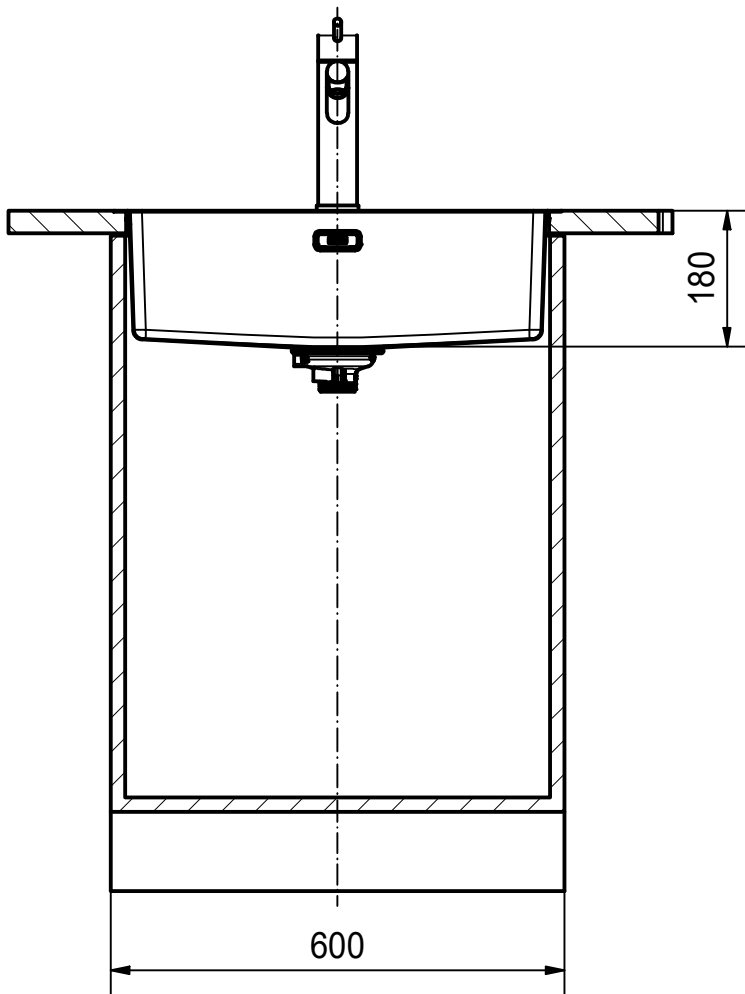

Drawing No.	20118343	Revision	-
Drawn Date	26.01.2018		
<small>These drawings and specifications are the property of Franke Technology and Trademark Ltd. and shall not be reproduced, copied or transferred to any third party without the prior written permission of Franke Technology and Trademark Ltd., Hergiswil, Switzerland</small>			



MRX 210-55 SI  
installing document

Sheet	Sheets
1	6

DS

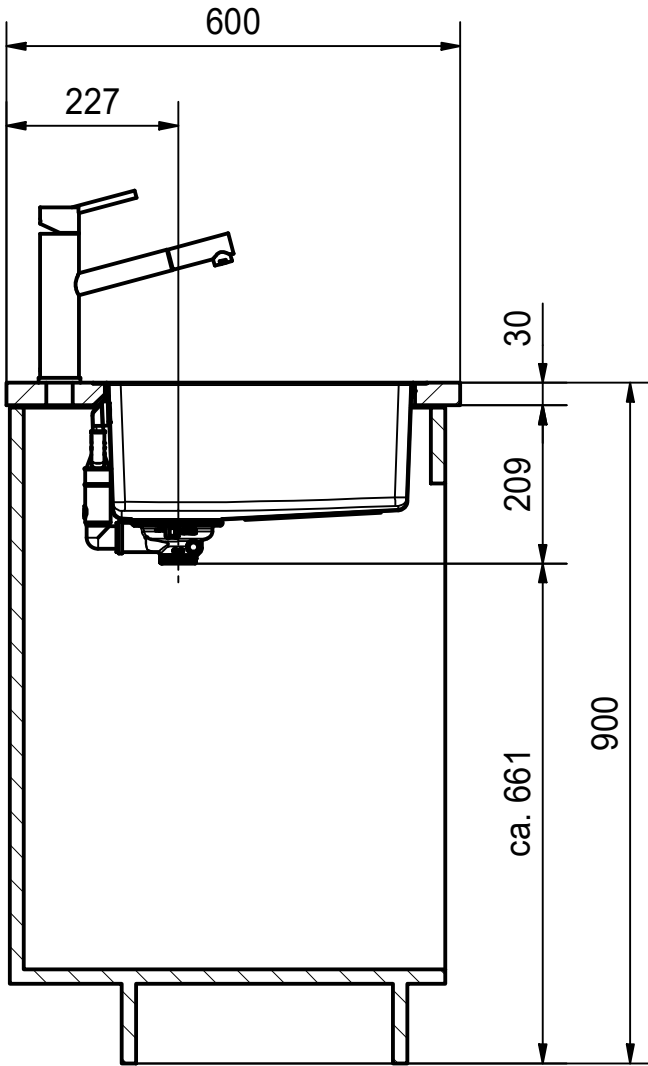

Drawing No.	20118343	Revision	-
Drawn Date	26.01.2018		
<small>These drawings and specifications are the property of Franke Technology and Trademark Ltd. and shall not be reproduced, copied or transferred to any third party without the prior written permission of Franke Technology and Trademark Ltd., Hergiswil, Switzerland</small>			



MRX 210-55 SI  
installing document

Sheet	Sheets
2	6

CO

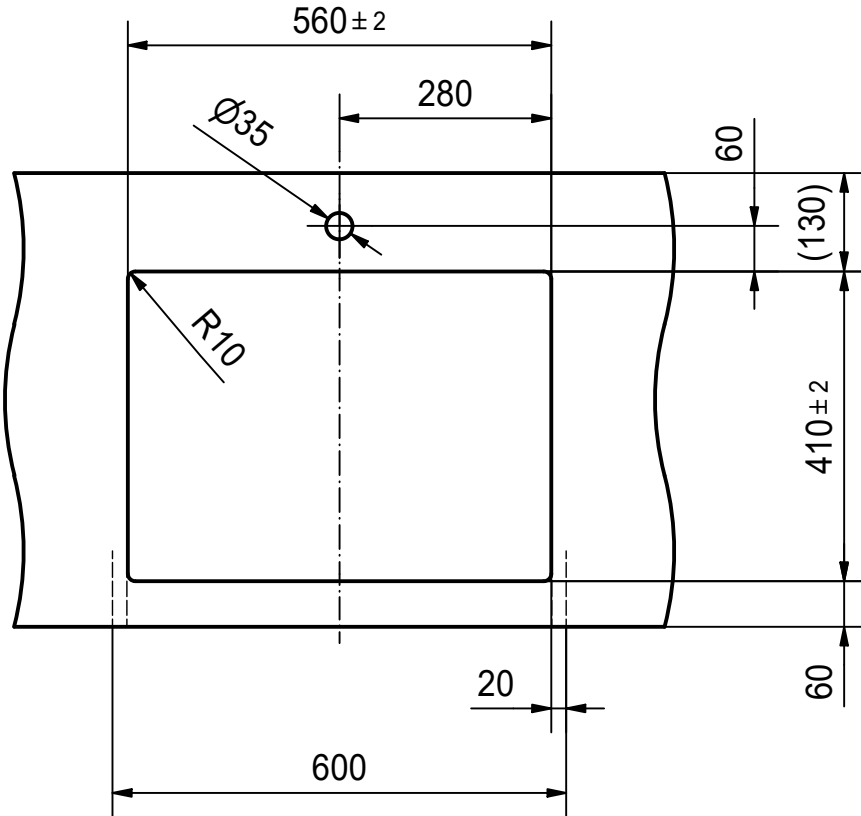

for flush fit only

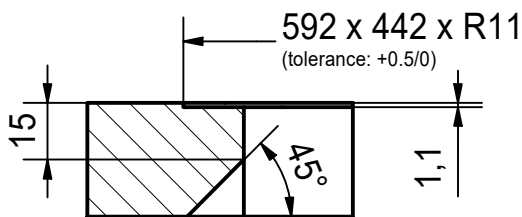

Drawing No.	20118343	Revision	-
Drawn Date	26.01.2018		
These drawings and specifications are the property of Franke Technology and Trademark Ltd. and shall not be reproduced, copied or transferred to any third party without the prior written permission of Franke Technology and Trademark Ltd., Hergiswil, Switzerland			



MRX 210-55 SI  
installing document

Sheet	Sheets
3	6

**CNC**



Drawing No.	20118343	Revision	-
Drawn Date	26.01.2018		
<small>These drawings and specifications are the property of Franke Technology and Trademark Ltd. and shall not be reproduced, copied or transferred to any third party without the prior written permission of Franke Technology and Trademark Ltd., Hergiswil, Switzerland</small>			



**MRX 210-55 SI**  
installing document

Sheet	Sheets
4	6

DT

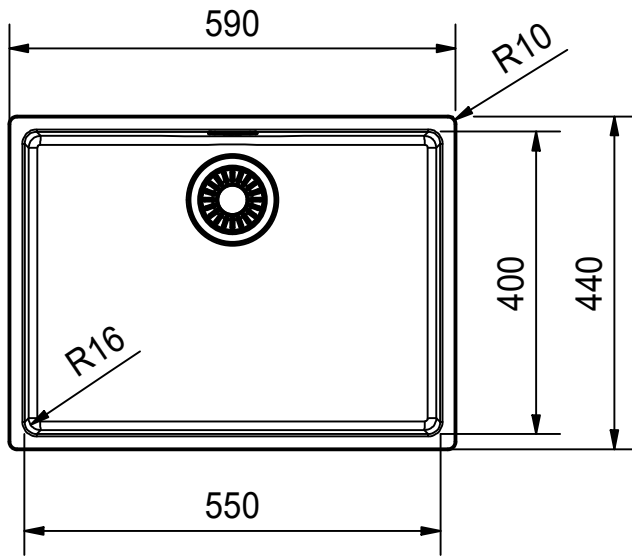

Drawing No.	20118343	Revision	-
Drawn Date	26.01.2018		
<small>These drawings and specifications are the property of Franke Technology and Trademark Ltd. and shall not be reproduced, copied or transferred to any third party without the prior written permission of Franke Technology and Trademark Ltd., Hergiswil, Switzerland</small>			



MRX 210-55 SI  
installing document

Sheet	Sheets
5	6

ISO

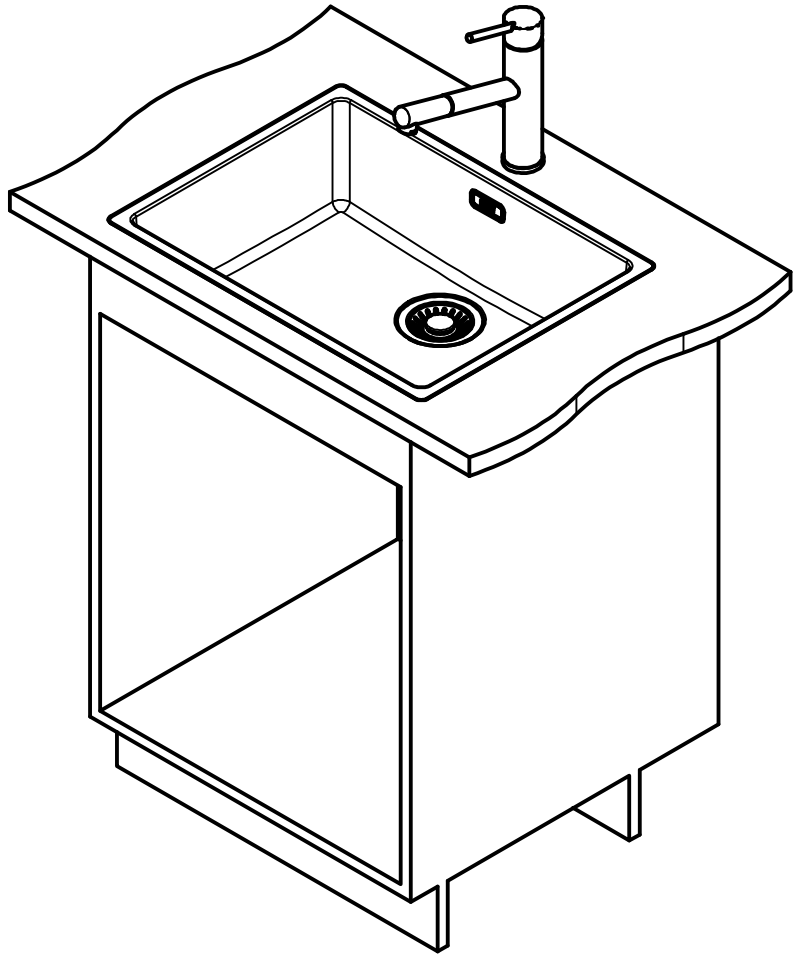

Drawing No.	20118343	Revision	-
Drawn Date	26.01.2018		
<small>These drawings and specifications are the property of Franke Technology and Trademark Ltd. and shall not be reproduced, copied or transferred to any third party without the prior written permission of Franke Technology and Trademark Ltd., Hergiswil, Switzerland</small>			



MRX 210-55 SI  
installing document

Sheet	Sheets
6	6