

DF

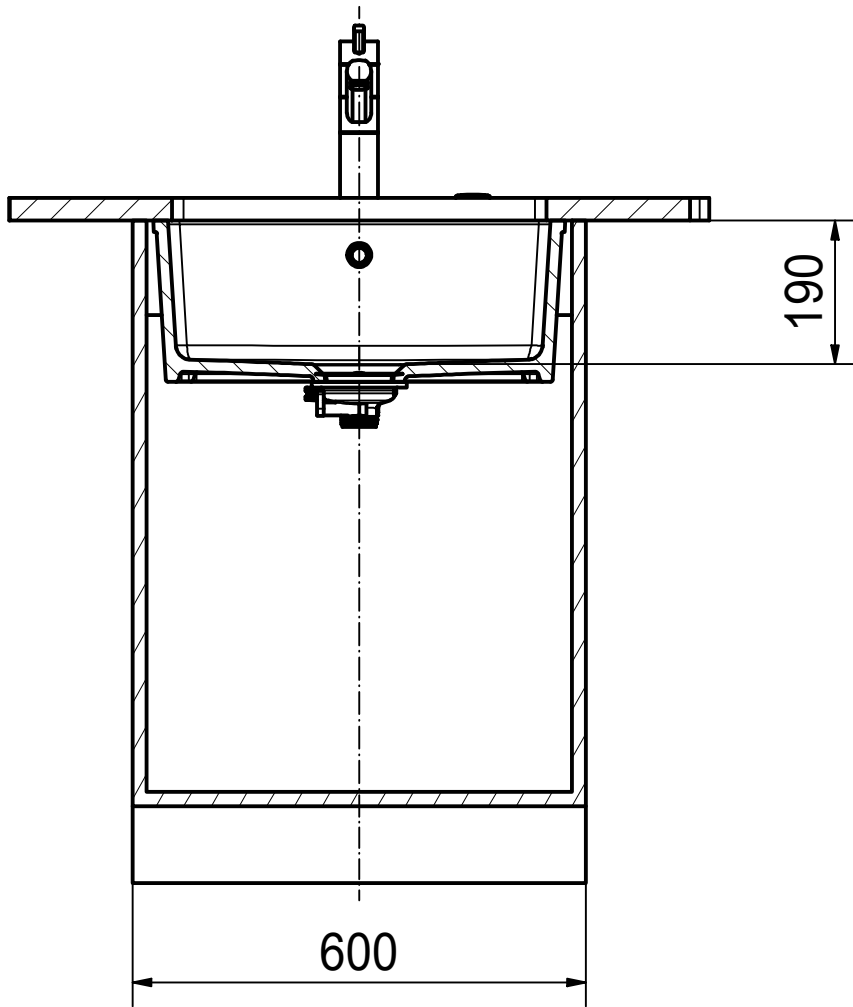

Drawing No.	20247079_01	Revision	-
Drawn Date	13.01.2023		
<small>These drawings and specifications are the property of Franke Technology and Trademark Ltd. and shall not be reproduced, copied or transferred to any third party without the prior written permission of Franke Technology and Trademark Ltd., Hergiswil, Switzerland</small>			

Franke Küchentechnik AG
CH-4663 Aarburg
Phone: +41 62 787 31 31
Internet: www.franke.com

KBK 110-50

Sheet	Sheets
1	6

DS

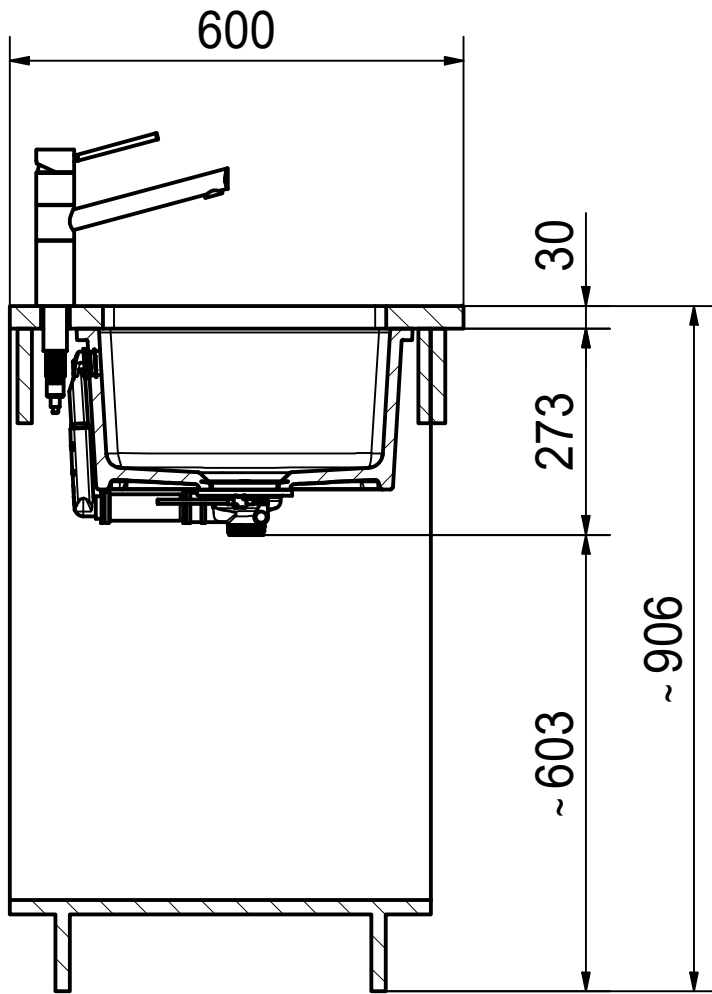

Drawing No.	20247079_01	Revision	-
Drawn Date	13.01.203		
<small>These drawings and specifications are the property of Franke Technology and Trademark Ltd. and shall not be reproduced, copied or transferred to any third party without the prior written permission of Franke Technology and Trademark Ltd., Hergiswil, Switzerland</small>			

Franke Küchentechnik AG
CH-4663 Aarburg
Phone: +41 62 787 31 31
Internet: www.franke.com

KBK 110-50

Sheet	Sheets
2	6

CO

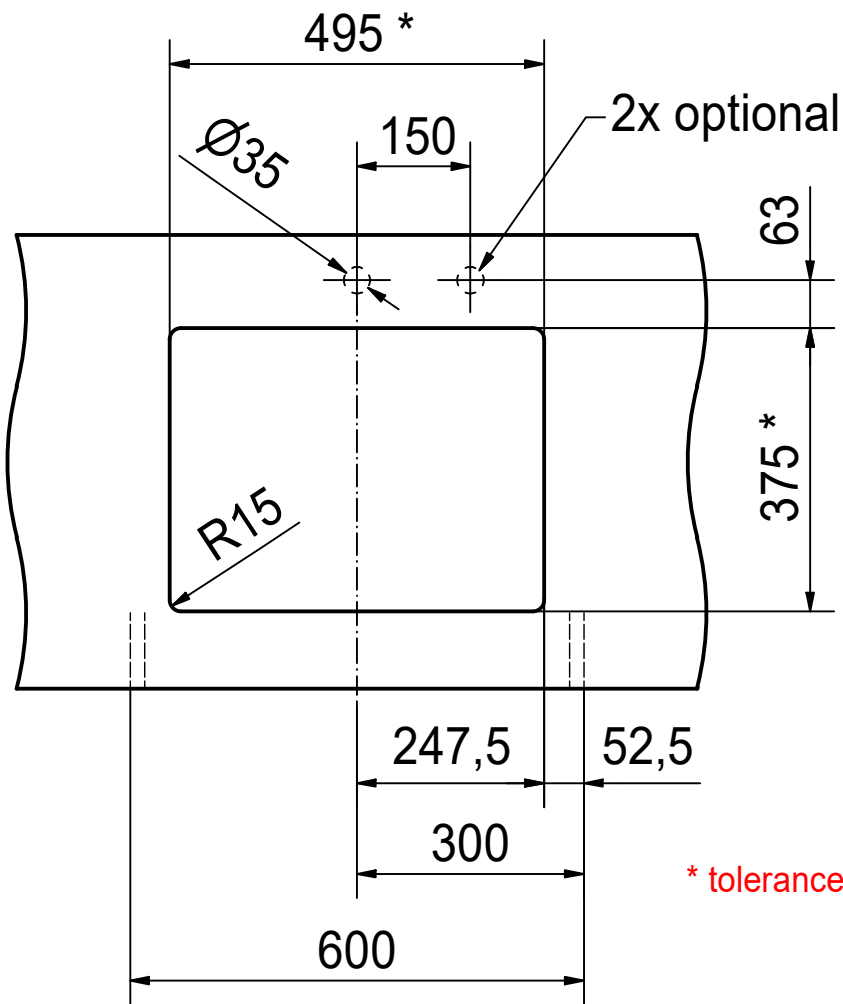

Due to material tolerances, it is recommended to make the cutout based on the supplied sink.

Drawing No.	20247079_01	Revision	-
Drawn Date	13.01.2023		
<small>These drawings and specifications are the property of Franke Technology and Trademark Ltd. and shall not be reproduced, copied or transferred to any third party without the prior written permission of Franke Technology and Trademark Ltd., Hergiswil, Switzerland</small>			

Franke Küchentechnik AG
CH-4663 Aarburg
Phone: +41 62 787 31 31
Internet: www.franke.com

KBK 110-50

Sheet	Sheets
3	6

CNC



Drawing No.	20247079_01	Revision	-
Drawn Date	13.01.203		
<small>These drawings and specifications are the property of Franke Technology and Trademark Ltd. and shall not be reproduced, copied or transferred to any third party without the prior written permission of Franke Technology and Trademark Ltd., Hergiswil, Switzerland</small>			

Franke Küchentechnik AG
CH-4663 Aarburg
Phone: +41 62 787 31 31
Internet: www.franke.com

KBK 110-50

Sheet	Sheets
4	6

DT

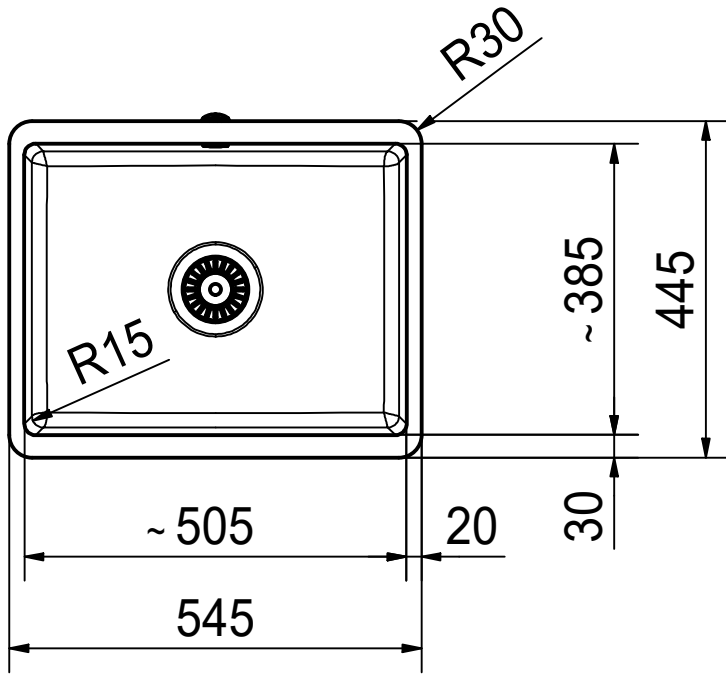

Drawing No.	20247079_01	Revision	-
Drawn Date	13.01.203		
<small>These drawings and specifications are the property of Franke Technology and Trademark Ltd. and shall not be reproduced, copied or transferred to any third party without the prior written permission of Franke Technology and Trademark Ltd., Hergiswil, Switzerland</small>			

Franke Küchentechnik AG
CH-4663 Aarburg
Phone: +41 62 787 31 31
Internet: www.franke.com

KBK 110-50

Sheet	Sheets
5	6

ISO

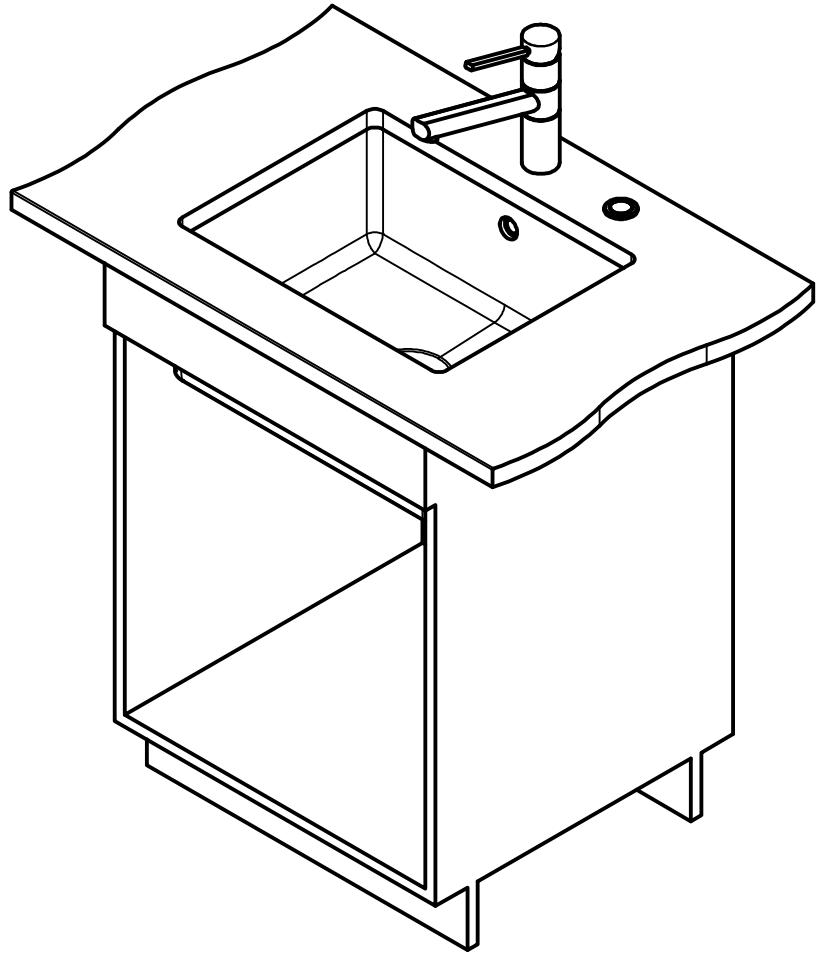

Drawing No.	20247079_01	Revision	-
Drawn Date	13.01.203		
<small>These drawings and specifications are the property of Franke Technology and Trademark Ltd. and shall not be reproduced, copied or transferred to any third party without the prior written permission of Franke Technology and Trademark Ltd., Hergiswil, Switzerland</small>			

Franke Küchentechnik AG
CH-4663 Aarburg
Phone: +41 62 787 31 31
Internet: www.franke.com

KBK 110-50

Sheet	Sheets
6	6