

DF

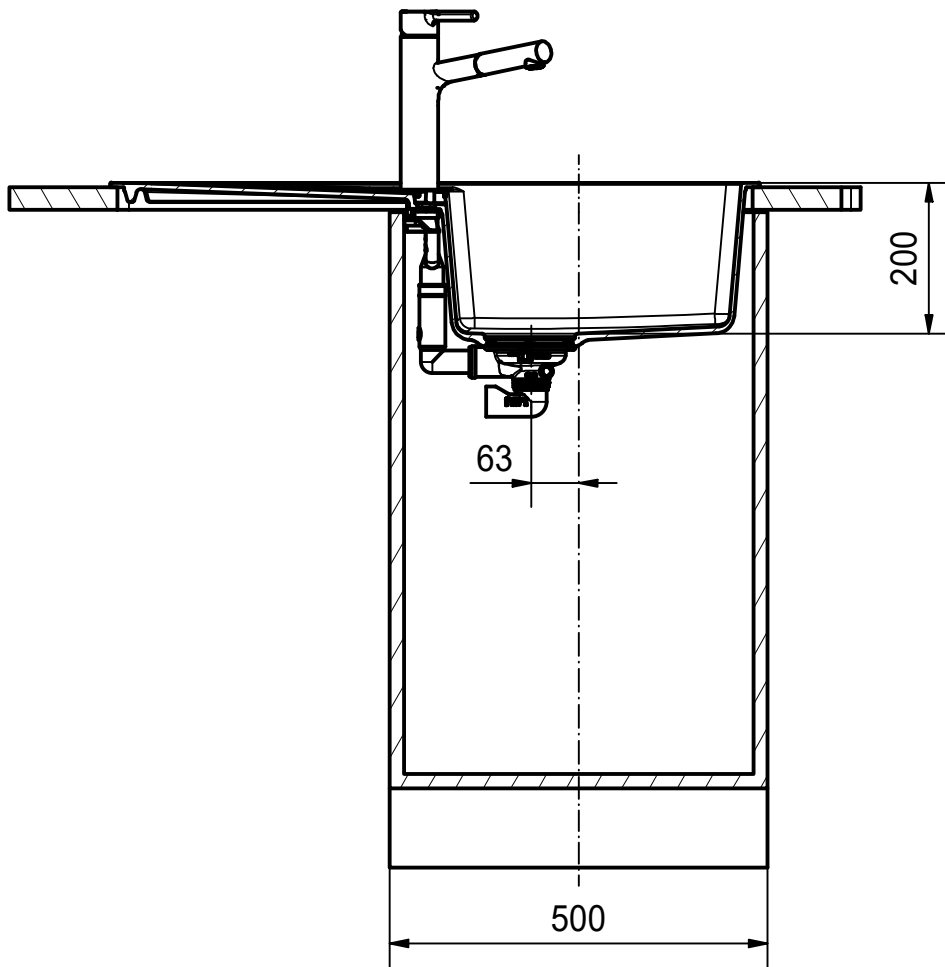

Drawing No.	20138104_03	Revision	B
Drawn Date	17.04.2019		
<small>These drawings and specifications are the property of Franke Technology and Trademark Ltd. and shall not be reproduced, copied or transferred to any third party without the prior written permission of Franke Technology and Trademark Ltd., Hergiswil, Switzerland</small>			

Franke Küchentechnik AG
CH-4663 Aarburg
Phone: +41 62 787 31 31
Internet: www.franke.com

CNG 611-86

installing document

Sheet	Sheets
1	6

DS

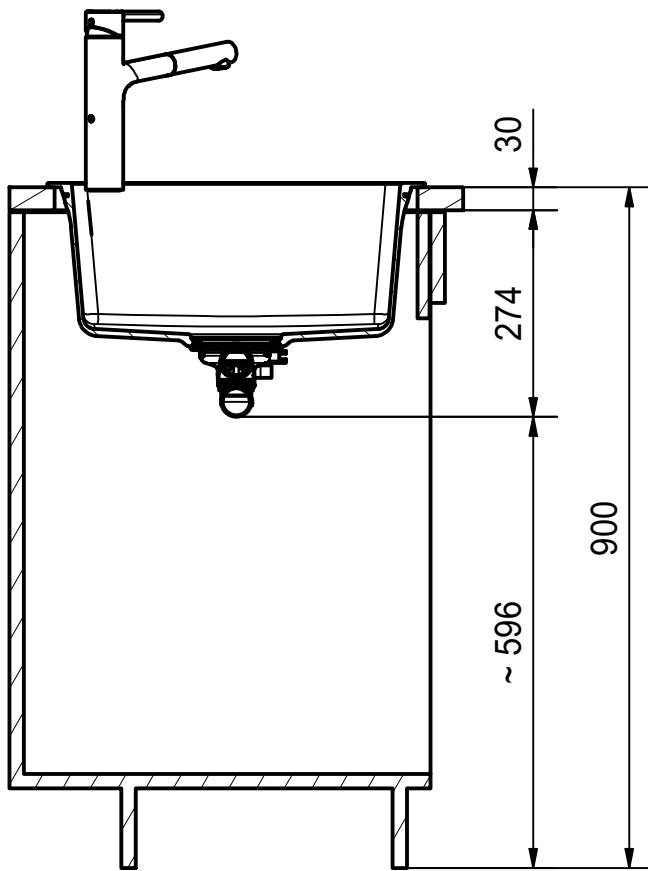

Drawing No.	20138104_03	Revision	B
Drawn Date	17.04.2019		
<small>These drawings and specifications are the property of Franke Technology and Trademark Ltd. and shall not be reproduced, copied or transferred to any third party without the prior written permission of Franke Technology and Trademark Ltd., Hergiswil, Switzerland</small>			

Franke Küchentechnik AG
CH-4663 Aarburg
Phone: +41 62 787 31 31
Internet: www.franke.com

CNG 611-86

installing document

Sheet	Sheets
2	6

CO

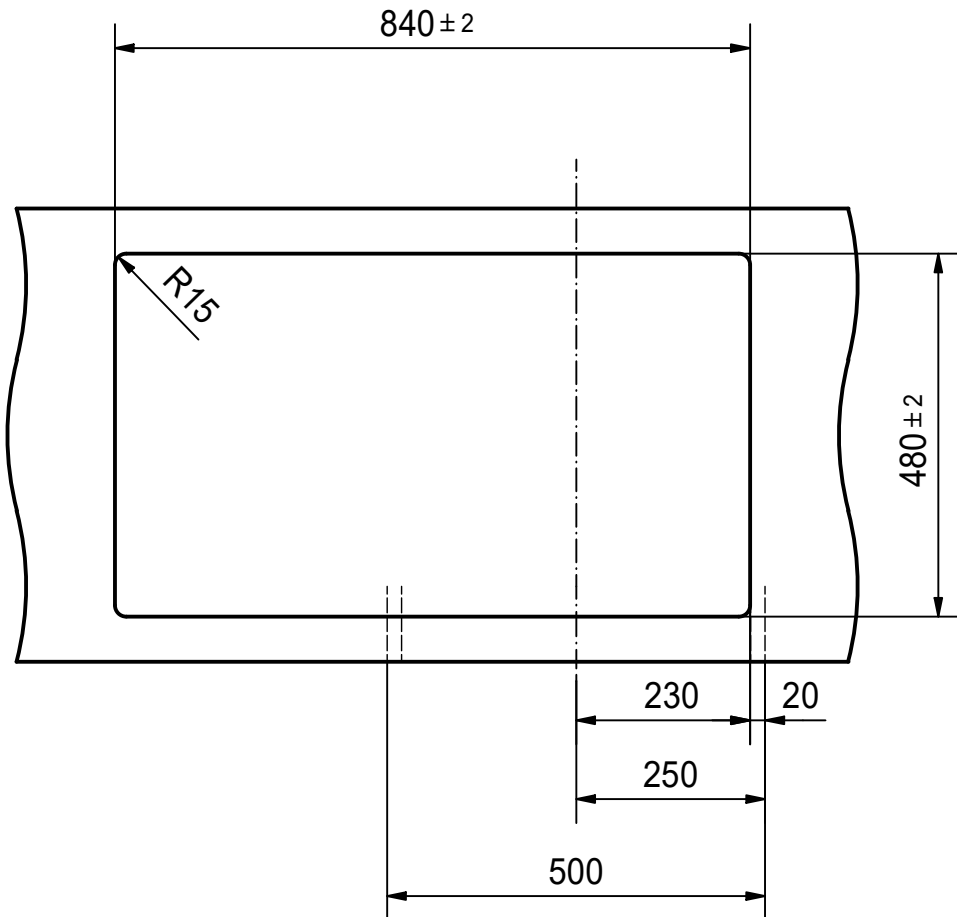

Drawing No.	20138104_03	Revision	B
Drawn Date	17.04.2019		
<small>These drawings and specifications are the property of Franke Technology and Trademark Ltd. and shall not be reproduced, copied or transferred to any third party without the prior written permission of Franke Technology and Trademark Ltd., Hergiswil, Switzerland</small>			

Franke Küchentechnik AG
CH-4663 Aarburg
Phone: +41 62 787 31 31
Internet: www.franke.com

CNG 611-86

installing document

Sheet	Sheets
3	6

CNC

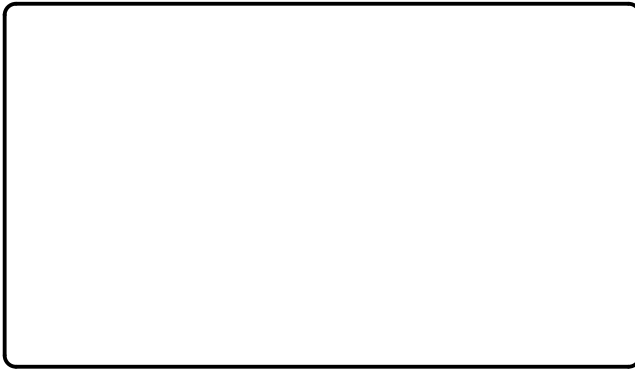

Drawing No.	20138104_03	Revision	B
Drawn Date	17.04.2019		
<small>These drawings and specifications are the property of Franke Technology and Trademark Ltd. and shall not be reproduced, copied or transferred to any third party without the prior written permission of Franke Technology and Trademark Ltd., Hergiswil, Switzerland</small>			

Franke Küchentechnik AG
CH-4663 Aarburg
Phone: +41 62 787 31 31
Internet: www.franke.com

CNG 611-86
installing document

Sheet	Sheets
4	6

DT

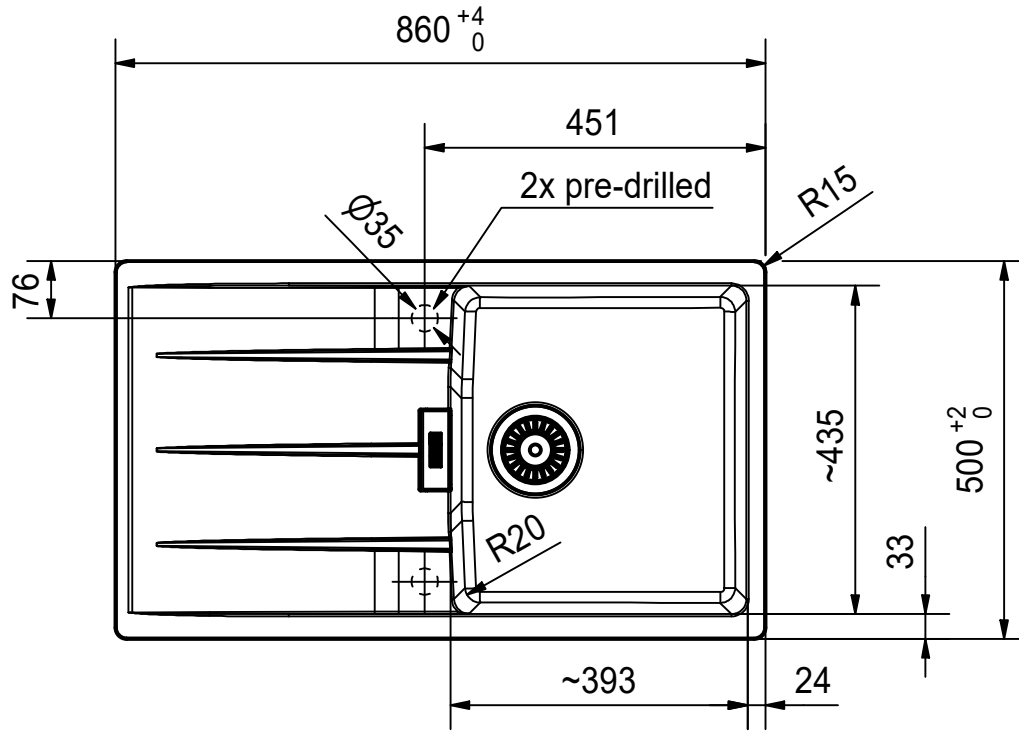

Drawing No.	20138104_03	Revision	B
Drawn Date	17.04.2019		
<small>These drawings and specifications are the property of Franke Technology and Trademark Ltd. and shall not be reproduced, copied or transferred to any third party without the prior written permission of Franke Technology and Trademark Ltd., Hergiswil, Switzerland</small>			

Franke K chentechnik AG
CH-4663 Aarburg
Phone: +41 62 787 31 31
Internet: www.franke.com

CNG 611-86

installing document

Sheet	Sheets
5	6

ISO

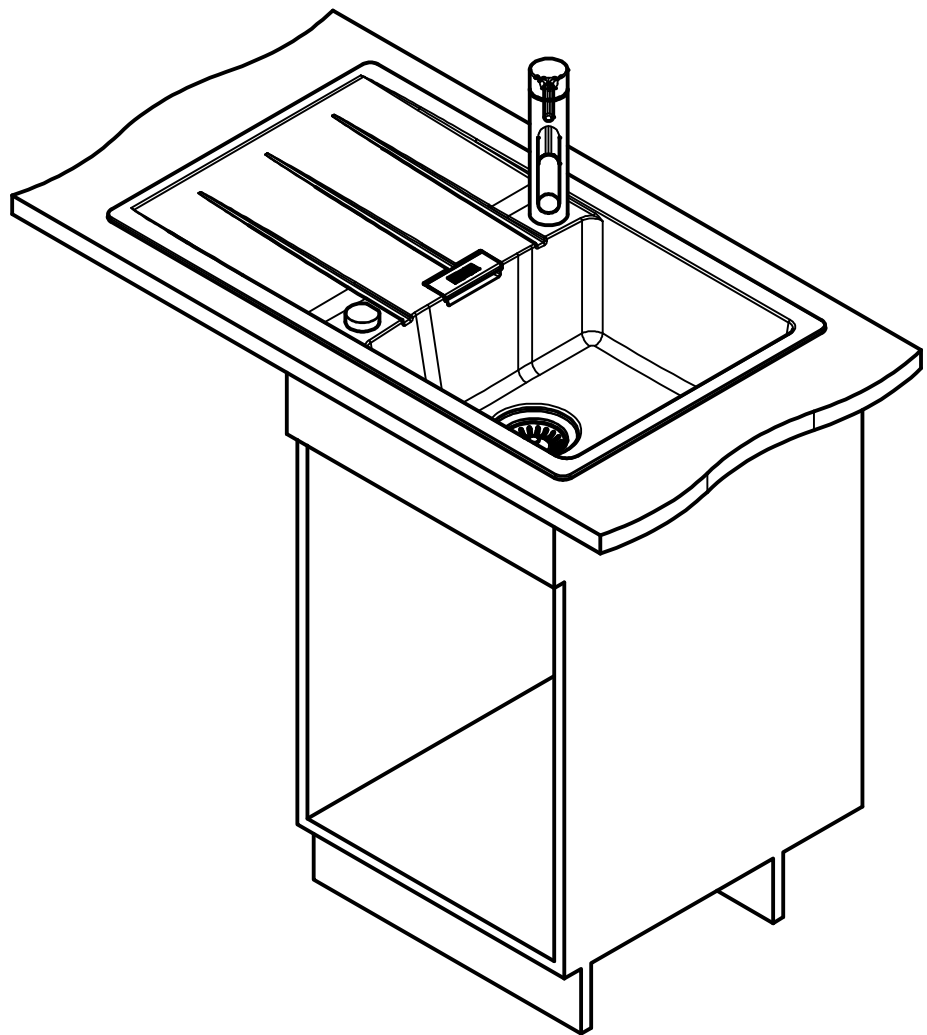

Drawing No.	20138104_03	Revision	B
Drawn Date	17.04.2019		
<small>These drawings and specifications are the property of Franke Technology and Trademark Ltd. and shall not be reproduced, copied or transferred to any third party without the prior written permission of Franke Technology and Trademark Ltd., Hergiswil, Switzerland</small>			

Franke Küchentechnik AG
CH-4663 Aarburg
Phone: +41 62 787 31 31
Internet: www.franke.com

CNG 611-86

installing document

Sheet	Sheets
6	6