

DF

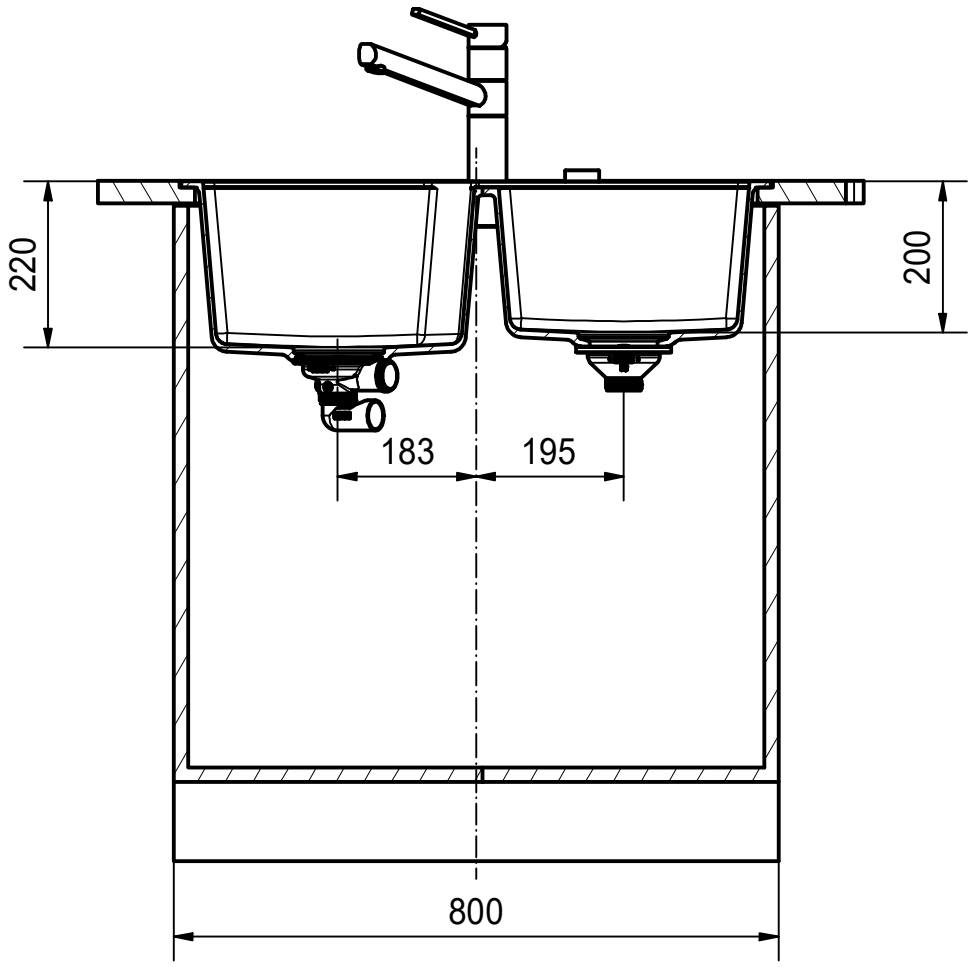

Drawing No.	20131825_01	Revision	-
Drawn Date	29.11.2018		
<small>These drawings and specifications are the property of Franke Technology and Trademark Ltd. and shall not be reproduced, copied or transferred to any third party without the prior written permission of Franke Technology and Trademark Ltd., Hergiswil, Switzerland</small>			

Franke Küchentechnik AG
CH-4663 Aarburg
Phone: +41 62 787 31 31
Internet: www.franke.com

UBG 220-78

installing document

Sheet	Sheets
1	6

DS

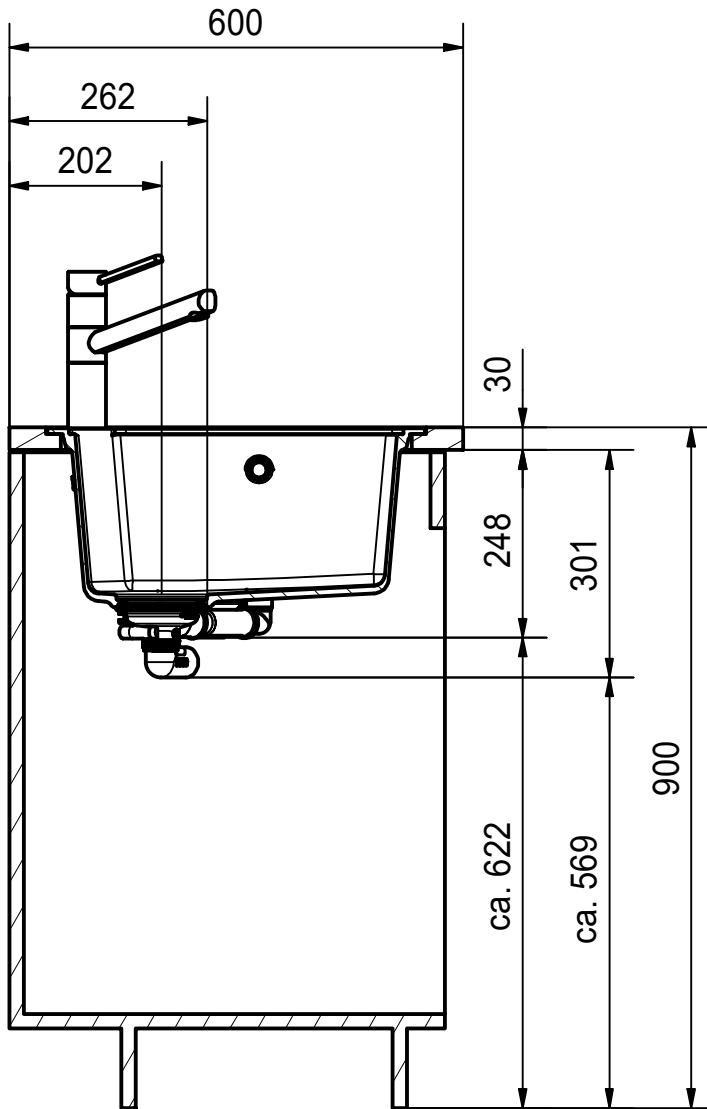

Drawing No.	20131825_01	Revision	-
Drawn Date	29.11.2018		
<small>These drawings and specifications are the property of Franke Technology and Trademark Ltd. and shall not be reproduced, copied or transferred to any third party without the prior written permission of Franke Technology and Trademark Ltd., Hergiswil, Switzerland</small>			

Franke Küchentechnik AG
CH-4663 Aarburg
Phone: +41 62 787 31 31
Internet: www.franke.com

UBG 220-78

installing document

Sheet	Sheets
2	6

CO

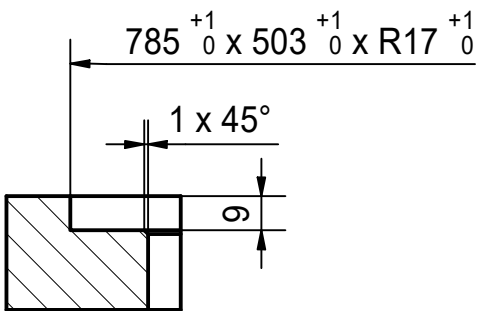
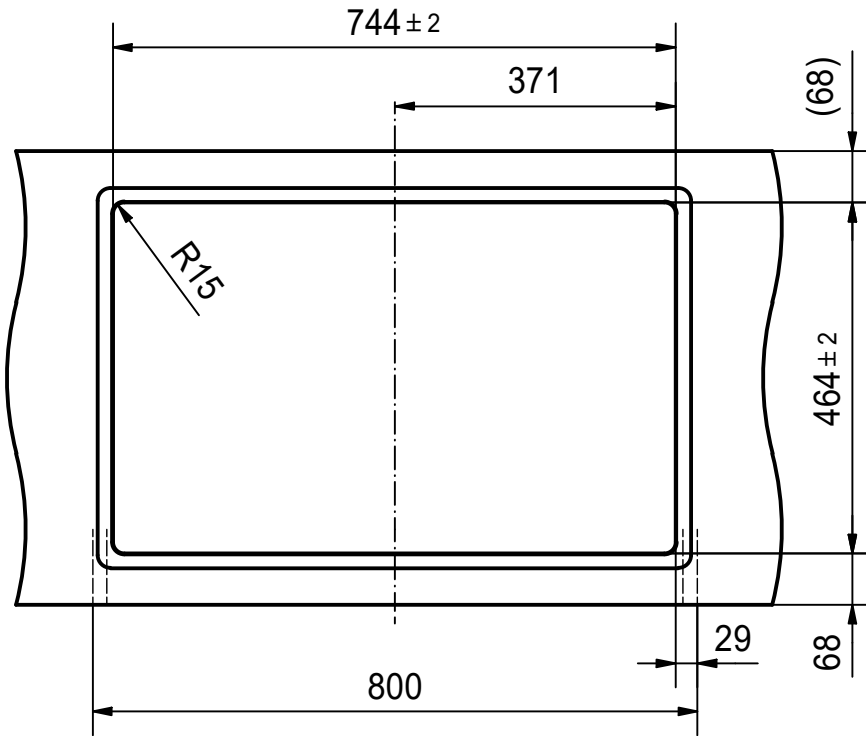

For flush fit only

Drawing No.	20131825_01	Revision	-
Drawn Date	29.11.2018		
These drawings and specifications are the property of Franke Technology and Trademark Ltd. and shall not be reproduced, copied or transferred to any third party without the prior written permission of Franke Technology and Trademark Ltd., Hergiswil, Switzerland			

Franke Küchentechnik AG
CH-4663 Aarburg
Phone: +41 62 787 31 31
Internet: www.franke.com

UBG 220-78
installing document

Sheet	Sheets
3	6

CNC



Drawing No.	20131825_01	Revision	-
Drawn Date	29.11.2018		
<small>These drawings and specifications are the property of Franke Technology and Trademark Ltd. and shall not be reproduced, copied or transferred to any third party without the prior written permission of Franke Technology and Trademark Ltd., Hergiswil, Switzerland</small>			

Franke Küchentechnik AG
CH-4663 Aarburg
Phone: +41 62 787 31 31
Internet: www.franke.com

UBG 220-78
installing document

Sheet	Sheets
4	6

ISO

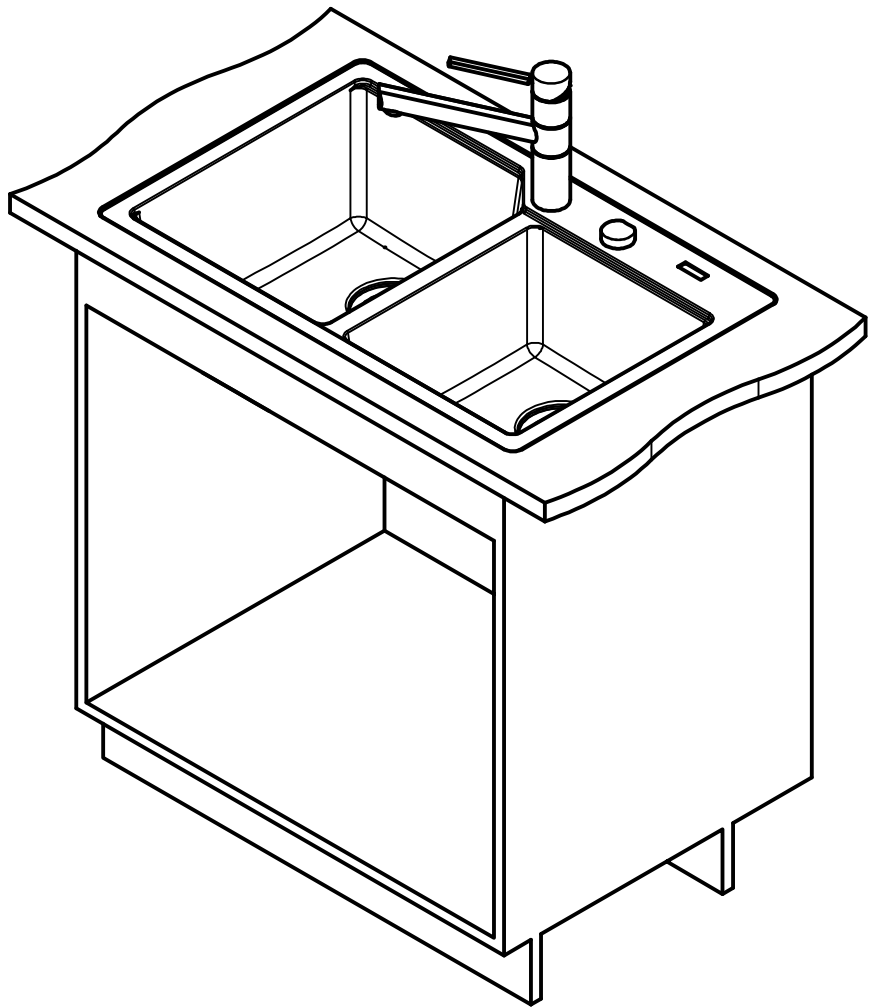

Drawing No.	20131825_01	Revision	-
Drawn Date	29.11.2018		
<small>These drawings and specifications are the property of Franke Technology and Trademark Ltd. and shall not be reproduced, copied or transferred to any third party without the prior written permission of Franke Technology and Trademark Ltd., Hergiswil, Switzerland</small>			

Franke Küchentechnik AG
CH-4663 Aarburg
Phone: +41 62 787 31 31
Internet: www.franke.com

UBG 220-78

installing document

Sheet	Sheets
6	6