

DF

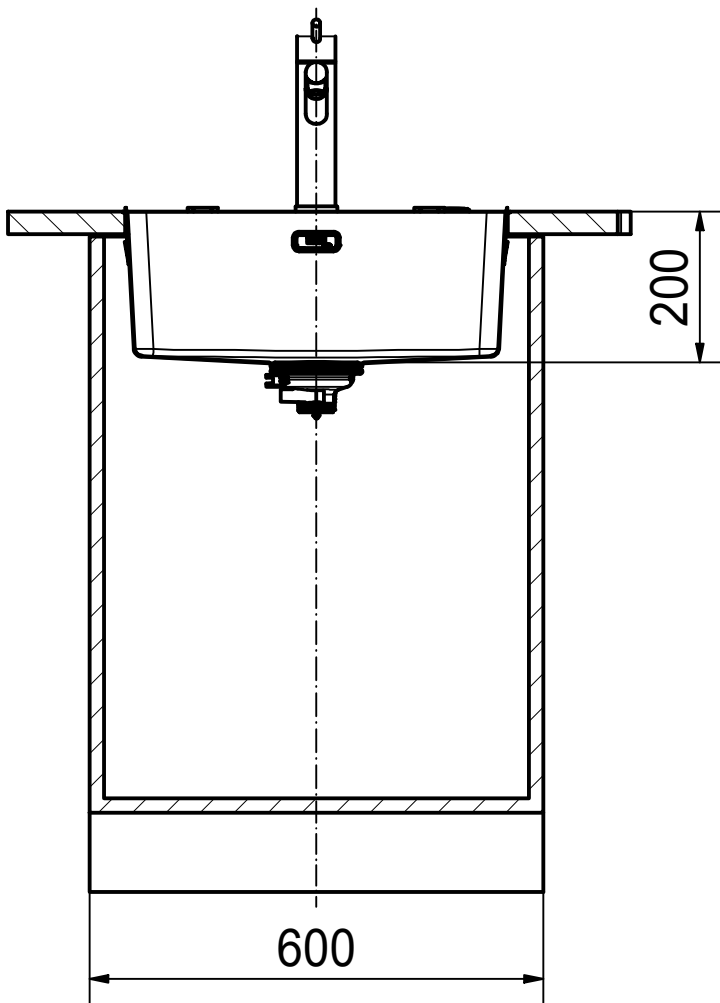

Drawing No.	20139358_02	Revision	A
Drawn Date	17.05.2019		
<small>These drawings and specifications are the property of Franke Technology and Trademark Ltd. and shall not be reproduced, copied or transferred to any third party without the prior written permission of Franke Technology and Trademark Ltd., Hergiswil, Switzerland</small>			



MYX 210-50 I
installing document

Sheet	Sheets
1	6

DS

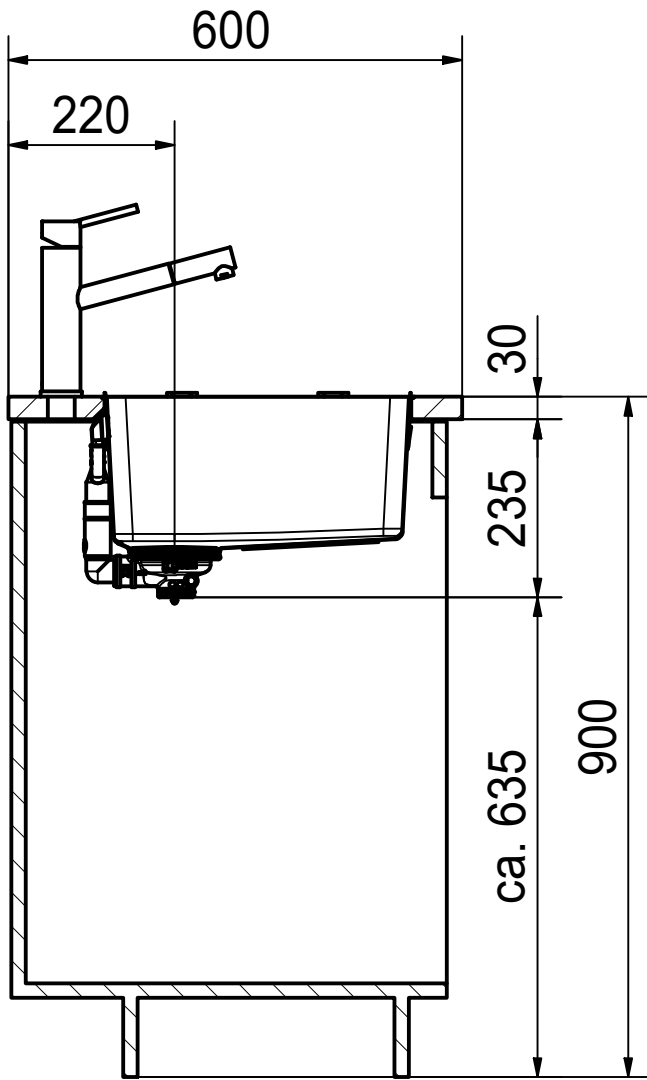

Drawing No.	20139358_02	Revision	A
Drawn Date	17.05.2019		
<small>These drawings and specifications are the property of Franke Technology and Trademark Ltd. and shall not be reproduced, copied or transferred to any third party without the prior written permission of Franke Technology and Trademark Ltd., Hergiswil, Switzerland</small>			



MYX 210-50 I
installing document

Sheet	Sheets
2	6

CO

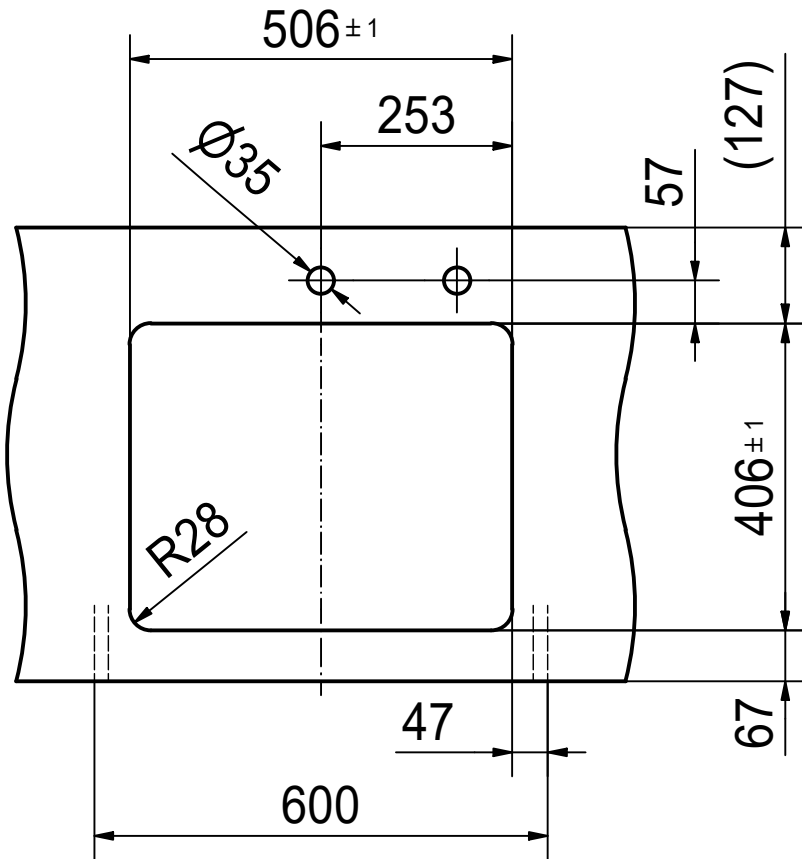

for flush fit only

512.4 x 412.4 x R31.2

(tolerance: +0.5/0)

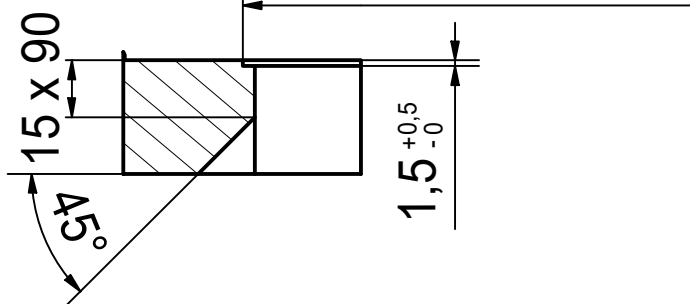

Drawing No.	20139358_02	Revision	A
Drawn Date	17.05.2019		
<small>These drawings and specifications are the property of Franke Technology and Trademark Ltd. and shall not be reproduced, copied or transferred to any third party without the prior written permission of Franke Technology and Trademark Ltd., Hergiswil, Switzerland</small>			



MYX 210-50 I
installing document

Sheet	Sheets
3	6

CNC



Drawing No.	20139358_02	Revision	A
Drawn Date	17.05.2019		
<small>These drawings and specifications are the property of Franke Technology and Trademark Ltd. and shall not be reproduced, copied or transferred to any third party without the prior written permission of Franke Technology and Trademark Ltd., Hergiswil, Switzerland</small>			



MYX 210-50 I
installing document

Sheet	Sheets
4	6

DT

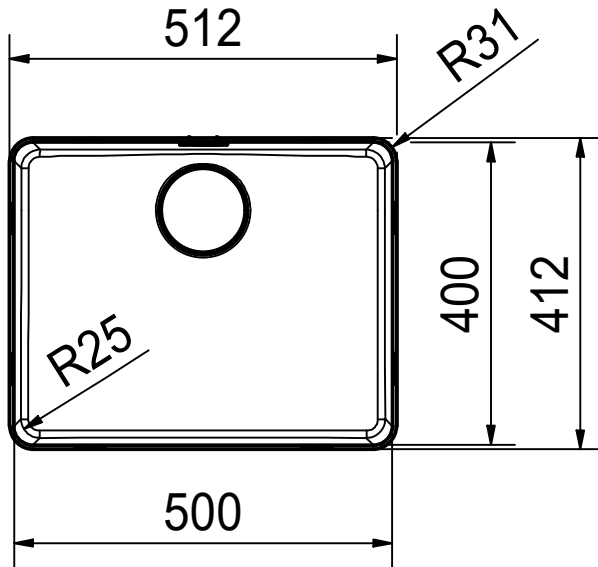

Drawing No.	20139358_02	Revision	A
Drawn Date	17.05.2019		
<small>These drawings and specifications are the property of Franke Technology and Trademark Ltd. and shall not be reproduced, copied or transferred to any third party without the prior written permission of Franke Technology and Trademark Ltd., Hergiswil, Switzerland</small>			



MYX 210-50 I
installing document

Sheet	Sheets
5	6

ISO

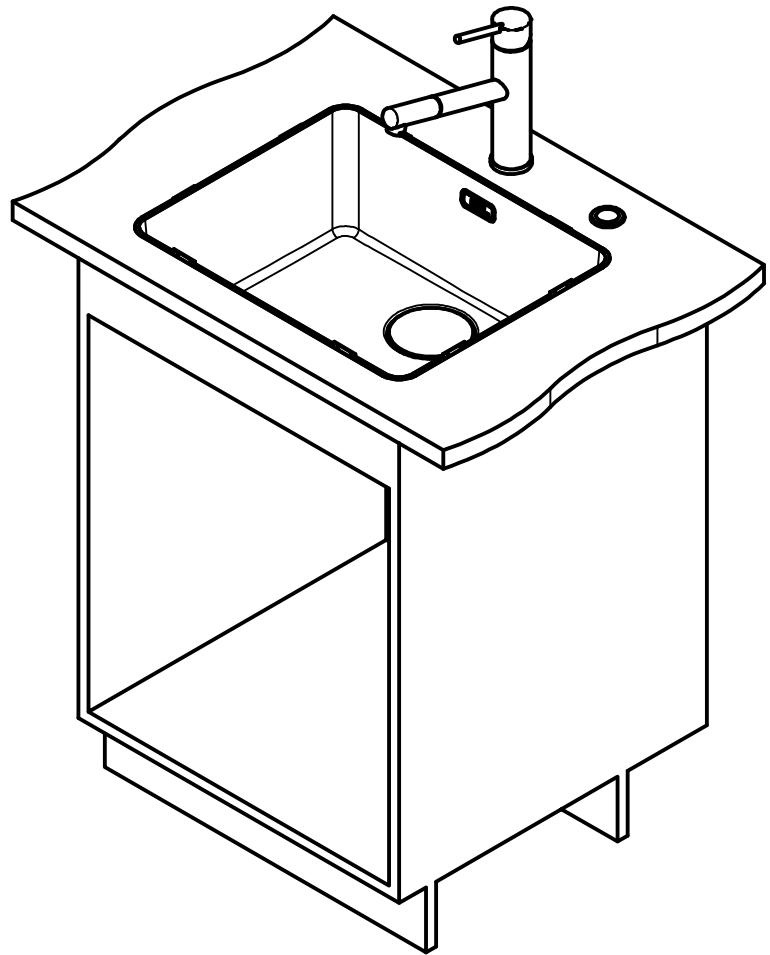

Drawing No.	20139358_02	Revision	A
Drawn Date	17.05.2019		
<small>These drawings and specifications are the property of Franke Technology and Trademark Ltd. and shall not be reproduced, copied or transferred to any third party without the prior written permission of Franke Technology and Trademark Ltd., Hergiswil, Switzerland</small>			



MYX 210-50 I
installing document

Sheet	Sheets
6	6