

DF

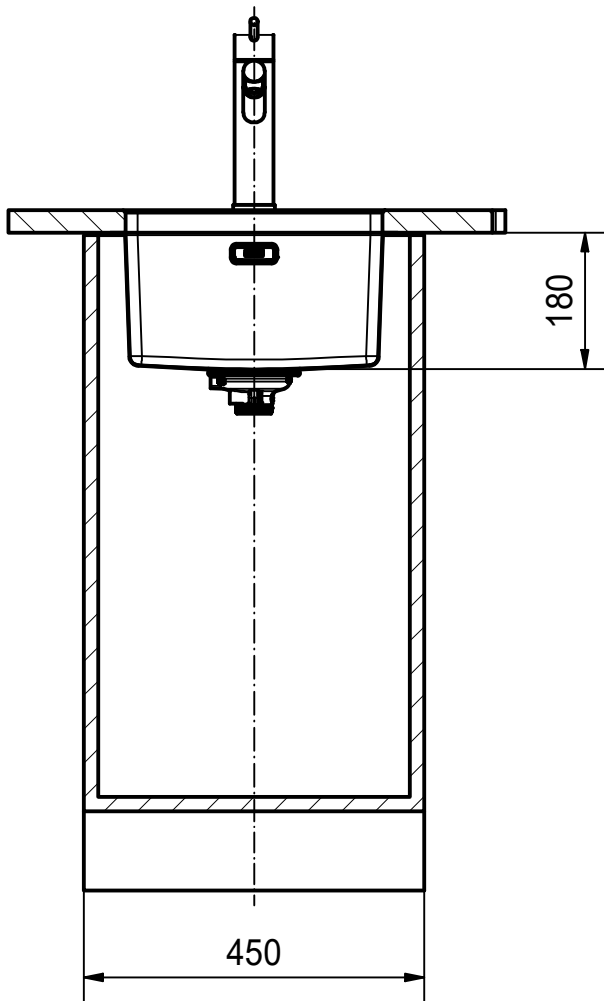

Drawing No.	20118307	Revision	-
Drawn Date	08.08.2017		
<small>These drawings and specifications are the property of Franke Technology and Trademark Ltd. and shall not be reproduced, copied or transferred to any third party without the prior written permission of Franke Technology and Trademark Ltd., Hergiswil, Switzerland</small>			



MRX 110-34 SI
installing document

Sheet	Sheets
1	6

DS

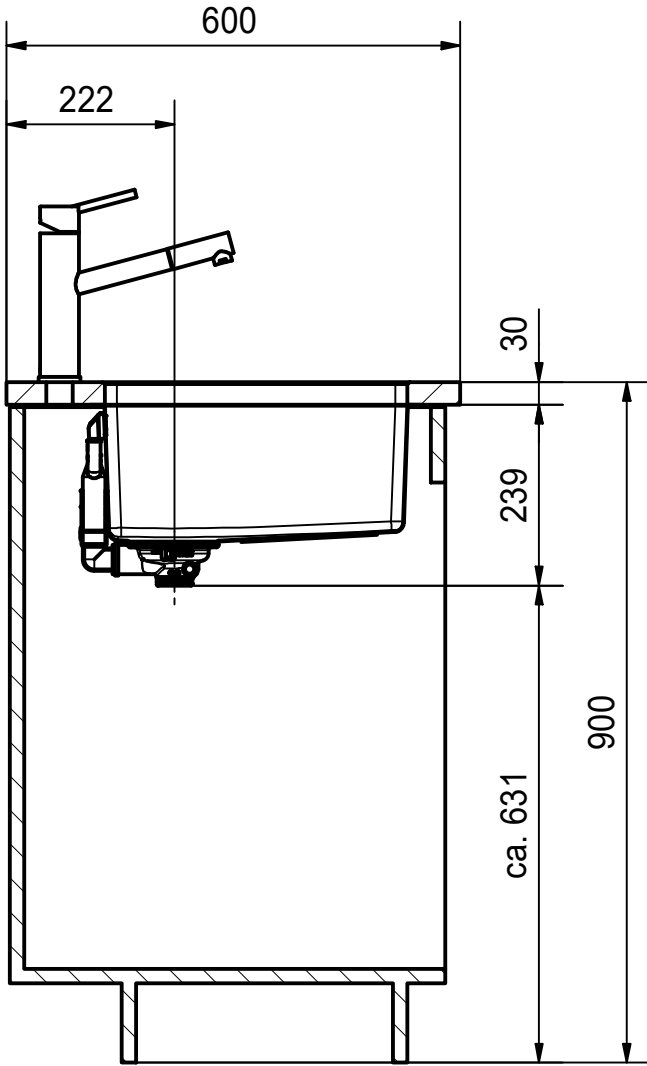

Drawing No.	20118307	Revision	-
Drawn Date	08.08.2017		
<small>These drawings and specifications are the property of Franke Technology and Trademark Ltd. and shall not be reproduced, copied or transferred to any third party without the prior written permission of Franke Technology and Trademark Ltd., Hergiswil, Switzerland</small>			



MRX 110-34 SI
installing document

Sheet	Sheets
2	6

CO

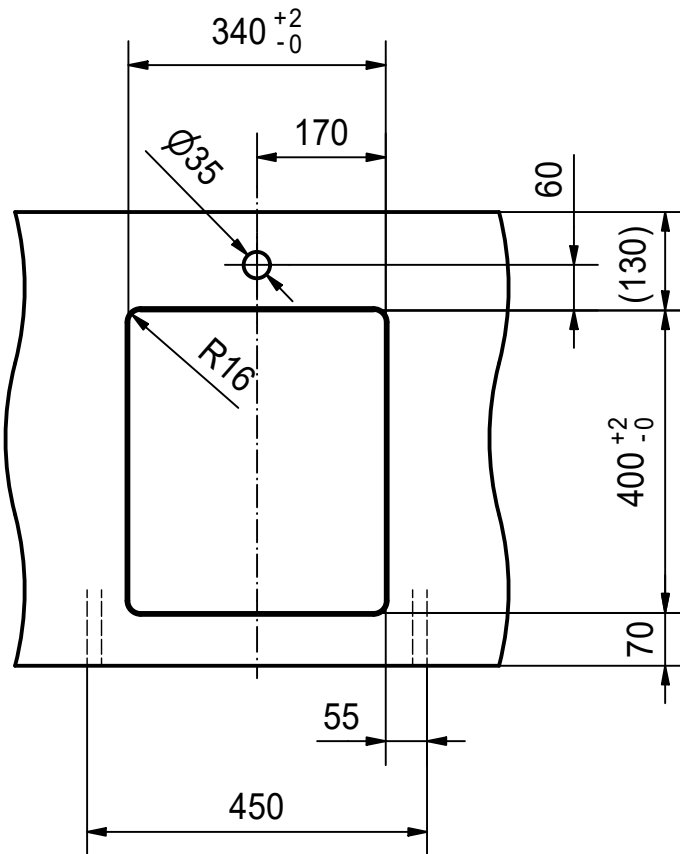

Drawing No.	20118307	Revision	-
Drawn Date	08.08.2017		
<small>These drawings and specifications are the property of Franke Technology and Trademark Ltd. and shall not be reproduced, copied or transferred to any third party without the prior written permission of Franke Technology and Trademark Ltd., Hergiswil, Switzerland</small>			



MRX 110-34 SI
installing document

Sheet	Sheets
3	6

CNC

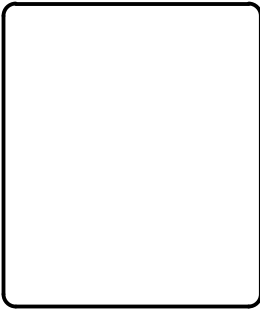

Drawing No.	20118307	Revision	-
Drawn Date	08.08.2017		
<small>These drawings and specifications are the property of Franke Technology and Trademark Ltd. and shall not be reproduced, copied or transferred to any third party without the prior written permission of Franke Technology and Trademark Ltd., Hergiswil, Switzerland</small>			



MRX 110-34 SI
installing document

Sheet	Sheets
4	6

DT

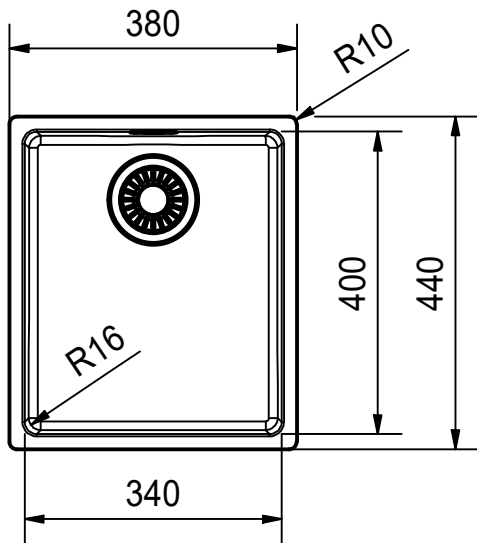

Drawing No.	20118307	Revision	-
Drawn Date	08.08.2017		
<small>These drawings and specifications are the property of Franke Technology and Trademark Ltd. and shall not be reproduced, copied or transferred to any third party without the prior written permission of Franke Technology and Trademark Ltd., Hergiswil, Switzerland</small>			



MRX 110-34 SI
installing document

Sheet	Sheets
5	6

ISO

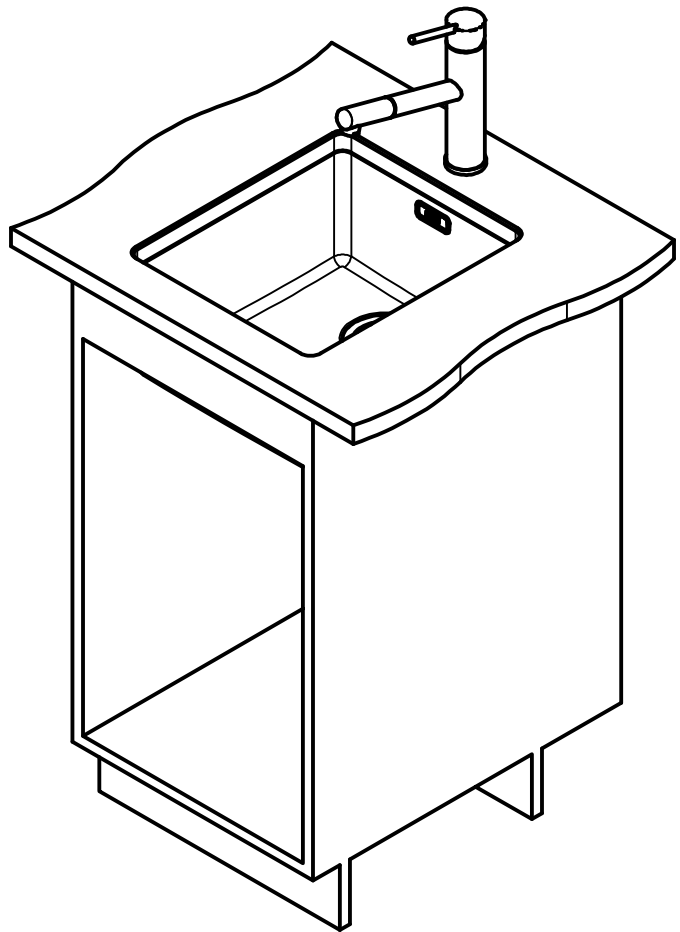

Drawing No.	20118307	Revision	-
Drawn Date	08.08.2017		
<small>These drawings and specifications are the property of Franke Technology and Trademark Ltd. and shall not be reproduced, copied or transferred to any third party without the prior written permission of Franke Technology and Trademark Ltd., Hergiswil, Switzerland</small>			



MRX 110-34 SI
installing document

Sheet	Sheets
6	6